

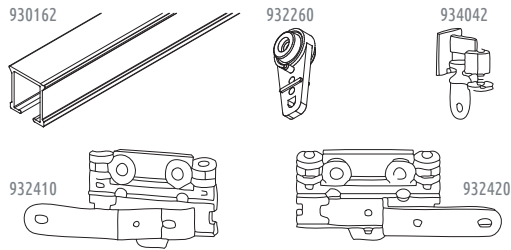

## Rieles GD / GD rails

### Riel Maastricht / Maastricht rail



Ref.	Artículo / Article	Uni.	Datos / Data	Color	Mat.
930162	Perfil Maastricht / Maastricht profile	60m	20x20mm	B	Alum
932260	Corredera Maastricht / Maastricht carrier	500 u.		B	POM
934042	Tapa Maastricht / Maastricht end cap	100 u.	932060	B	POM
932410	Maestra Maastricht D / Maastricht master R	50 u.	External	B	Met
932420	Maestra Maastricht I / Maastricht master L	50 u.	Internal	B	Met

### Riel Utrecht / Utrecht rail

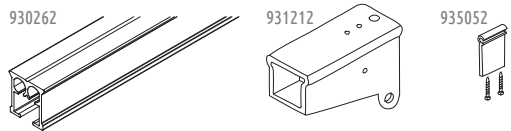

Ref.	Artículo / Article	Uni.	Datos / Data	Color	Mat.
930262	Perfil Utrecht / Utrecht profile	60m	20x20mm	B	Alum
931212	Polea Utrecht / Utrecht pulley	50 u.	Cord.Ø3,5mm	B	POM
935052	Trineo Utrecht / Utrecht cord clipper	150 u.	Cord.Ø3,5mm	B	POM

### Riel Breda / Breda rail

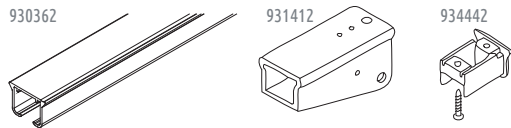

Ref.	Artículo / Article	Uni.	Datos / Data	Color	Mat.
930362	Perfil Breda / Breda profile	120m	20x14mm	B	Alum
931412	Polea Breda / Breda pulley	50 u.	Cord.Ø2mm	B	POM
934442	Tapa Breda / Breda end cap	200 u.	20x14mm	B	POM

### Sistema a cordón / Cord system

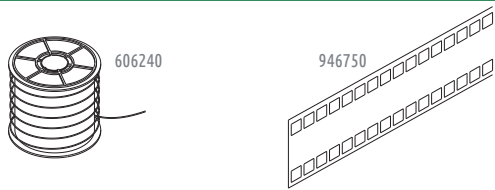

Ref.	Artículo / Article	Uni.	Datos / Data	Color	Mat.
606240	Cordón con alma / Cord with core	200m	Ø2,4mm	3 colors	PET
946750	Cinta Onda Perfecta / Wave system tape	150m	75mm	B Bg	PE

### Correderas / Runners

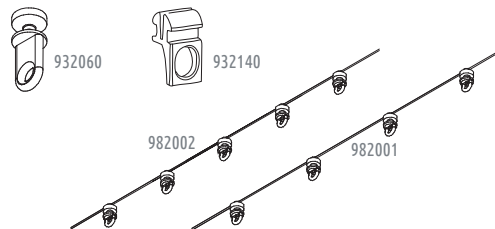

Ref.	Artículo / Article	Uni.	Datos / Data	Color	Mat.
932060	Corredera giratoria / Rotary skate runner	500 u.		B	POM
932140	Corredera pinza / Side skate carrier	500 u.		B	POM
982002	Cordón+corredera patín/Carrier+cord+snap	60m	1.000u. x60mm	B	POM
982001	Cordón+corredera patín/Carrier+cord+snap	80m	1.000u. x80mm	B	POM

### Correderas maestras / Master runners

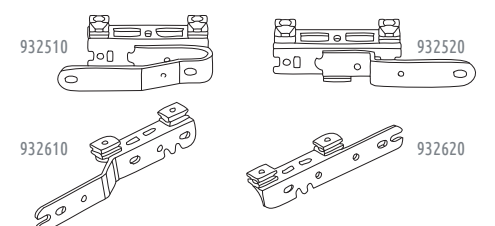

Ref.	Artículo / Article	Uni.	Datos / Data	Color	Mat.
932510	Maestra Utrecht der. / Utrecht master right	25 u.	External	B	Met
932520	Maestra Utrecht izq. / Utrecht master left	25 u.	Internal	B	Met
932610	Maestra Breda der. / Breda master right	25 u.	External	B	Met
932620	Maestra Breda izq. / Breda master left	50 u.	Internal	B	Met

## Soportes / Supports

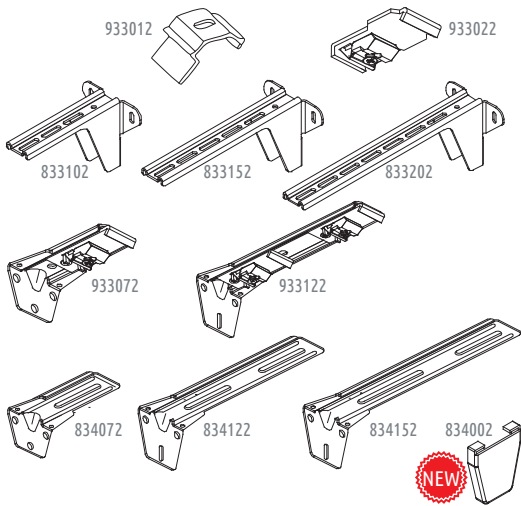

Ref.	Artículo / Article	Uni.	Datos / Data	Color	Mat.
933012	Soporte grapa GD / GD ceiling clip	500 u.		B G	Met
933022	Soporte techo GD / GD ceiling bracket	100 u.		B	Met
833102	Escuadra extra / Wall bracket 10cm	50 u.	26x63x100mm	B	Met
833152	Escuadra extra / Wall bracket 15cm	50 u.	26x63x150mm	B	Met
833202	Escuadra extra / Wall bracket 20cm	50 u.	26x63x200mm	B	Met
933072	Sop. frontal GD / GD front bracket	50 u.	75mm	B	Met
933122	Sop. frontal GD / GD front bracket	25 u.	125mm	B	Met
834072	Escuadra colisos / Bracket with holes	100 u.	75mm	B	Met
834122	Escuadra colisos / Bracket with holes	50 u.	125mm	B	Met
834152	Escuadra colisos / Bracket with holes	50 u.	150mm	B	Met
834002	Tapa-tornillos / Screws cover	50 u.	50x57mm	B	PP

## Contrapesos / Counterweights

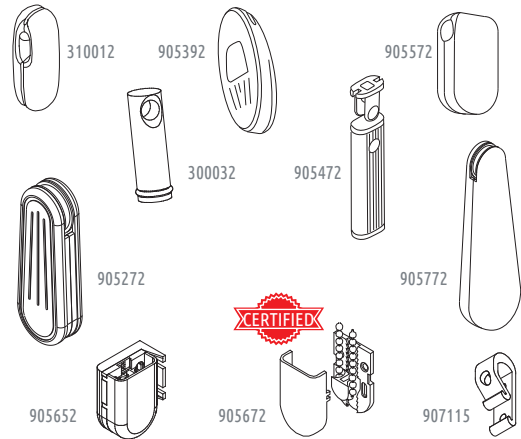

Ref.	Artículo / Article	Uni.	Datos / Data	Color	Mat.
310012	Contrapeso Rutroller / Rutroller count.	60 u.	25g Ø20x60	B G N Bg Tr	PP
905392	Contrapeso Turín / Turin counterweight	40 u.	48g 90x36x17	B G N Bg	PP
905572	Contrapeso Roma / Rome counterw.	40 u.	64g 59x37x20	B	PP
300032	Cont. Rutdecor / Rutdecor counterweight	25 u.	108g Ø20x65	Cn Cr Gt	Met
905472	Contrapeso Sidney / Sydney counterw.	40 u.	110g 100x15x32	B	ABS
905272	Contrapeso especial / Special counterw.	32 u.	115g 98x20x35	B G N	PP
905772	Contrapeso GD / GD counterweight	100 u.	200g 132x40x23	B G N Bg	ABS
905652	Tensor Lorca / Lorca taut	50 u.	47x22mm	B G N Bg	POM
905672	Tensor Murcia / Murcia taut	250 u.	47x32mm	B G N Bg	POM
907115	Tensor Yecla / Yecla taut	100 u.	50x20x16mm	Tr	PC

## Tiradores / Pull hand

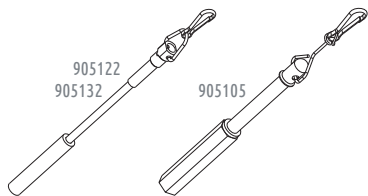

Ref.	Artículo / Article	Uni.	Datos / Data	Color	Mat.
905122	Tirador manual / Pull hand	25 u.	1m	B	Met
905132	Tirador manual / Pull hand	25 u.	1,5m	B	Met
905105	Tirador manual transp. / Transp. pull hand	25 u.	1m	Tr	PC

## Garfios / Hooks

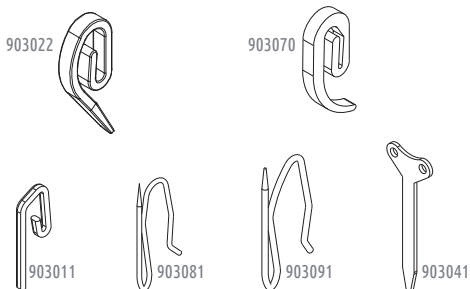

Ref.	Artículo / Article	Uni.	Datos / Data	Color	Mat.
903022	Garfio "A" / "A" hook	1.000 u.	32mm	B Tr	POM
903070	Garfio extra / Extra hook	1.000 u.	30mm	B Tr	POM
903011	Garfio metálico / Metallic hook	1.000 u.	28mm	Zn	Met
903081	Garfio alfiler Ø1,2 / Ø1,2 Pin hook	1.000 u.	Ø1,2mm	Zn	Met
903091	Garfio alfiler Ø1,5 / Ø1,5 Pin hook	500 u.	Ø1,5mm	Zn	Met
903041	Garfio espada metal / Metal sword hook	1.000 u.	42mm	Zn	Met

## Tornillos / Screws

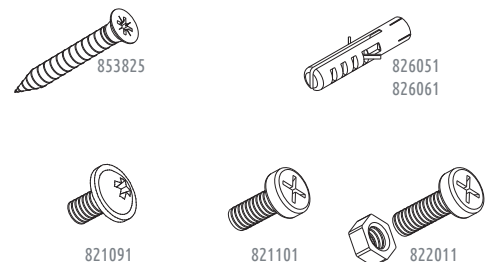

Ref.	Artículo / Article	Uni.	Datos / Data	Color	Mat.
853825	Tornillo / Screw 4,0x30mm	1.000 u.	DIN7505A	Zn	Met
826051	Taco Ø5 / Ø5 plug	100 u.	Ø5x25mm	G	PA
826061	Taco Ø6 / Ø6 plug	100 u.	Ø6x30mm	G	PA
821091	Tornillo / Screw M4x 8mm	100 u.	DIN967	Zn	Met
821101	Tornillo / Screw M4x10mm	100 u.	DIN7985	Zn	Met
822011	Tornillo+tuerca / Screw+nut	1.000 u.	M4x12 + M4 hex	Zn	Met