

Compacto Teide / Teide compact

Perfiles / Profiles

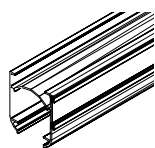

610462



680760

| Ref. | Artículo / Article | Uni. | Datos / Data | Color | Mat. |
|--------|------------------------------|------|--------------|----------|------|
| 610462 | Perfil Teide / Teide profile | 72m | 34x38mm | B G Bg N | Alum |
| 680760 | Barra cuadrada / Square rail | 360m | 5x5mm | Al | Alum |

Frenos / Control units

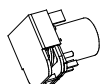

611052



611242

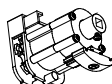

611252

| Ref. | Artículo / Article | Uni. | Datos / Data | Color | Mat. |
|--------|--|-------|-----------------|----------|------|
| 611052 | Freno Guadix T / Guadix Control Unit | 40 u. | rel.1:1 max.2kg | B | PA |
| 611242 | Freno Aneto 1:1 / Aneto 1:1 control unit | 50 u. | rel.1:1 max.2kg | B G Bg N | POM |
| 611252 | Freno Aneto 1:4 / Aneto 1:4 control unit | 25 u. | rel 1:4 max.8kg | B G Bg N | POM |

Guías / Cord guides

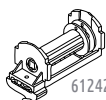

612420

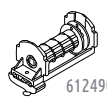

612490

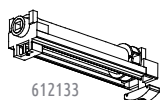

612133

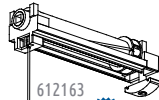

612163



613075



| Ref. | Artículo / Article | Uni. | Datos / Data | Color | Mat. |
|--------|-------------------------------------|--------|-----------------|-------|------|
| 612420 | Guía TMK Teide / TMK Teide guide | 50 u. | max.5m | B | PA |
| 612490 | Guía TMK +cordón / TMK guide+cord | 40 u. | cord2,5m max2kg | B | PA |
| 612133 | Guía Caché CE / Cache CE guide | 20 u. | 105x26mm | Tr | PC |
| 612163 | Guía CE +cordón / CE guide+cord | 20 u. | cord3m max900g | Tr | PC |
| 613075 | Clip escape cordón / Cord breakaway | 200 u. | max.4-6kg | Tr | PC |

Tapas / End caps



614062

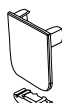

614033

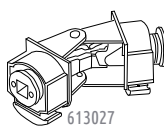

613027



720600

| Ref. | Artículo / Article | Uni. | Datos / Data | Color | Mat. |
|--------|-----------------------------------|--------|--------------|----------|------|
| 614062 | Tapa Teide / Teide end cap | 200 u. | 34x38mm | B G Bg N | PE |
| 614033 | Tapa + tornillo / End cap + screw | 100 u. | 34x37mm | B | PP |
| 613027 | Empalme ángulo / Angle joint | 25 u. | 90-270° | Tr | PC |
| 720600 | Anilla fijación / Binding ring | 50 u. | 5x5mm | D | Met |

Soportes / Supports

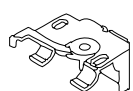

613022

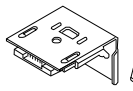

613021



613024

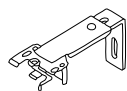

613023



613012

| Ref. | Artículo / Article | Uni. | Datos / Data | Color | Mat. |
|--------|---|--------|--------------|----------|------|
| 613022 | Soporte Mulhacén / Mulhacén support | 100 u. | 24x35mm | B | Met |
| 613021 | Soporte clip / Clip support | 100 u. | 38x38x26mm | B | Met |
| 613024 | Soporte techo / Ceiling support | 200 u. | | B | Met |
| 613023 | Soporte extensible / Extendable bracket | 50 u. | 100-130mm | B | Met |
| 613012 | Soporte plástico / Plastic support | 200 u. | 28x48mm | B G Bg N | PA |

Varillas / Rods

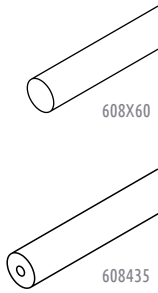

| Ref. | Artículo / Article | Uni. | Datos / Data | Color | Mat. |
|--------|--|--------|--------------|-------|------|
| 608360 | Varilla de fibra / Fibre rod | 3.000m | Ø3mm 6m | B | FV |
| 608460 | Varilla de fibra / Fibre rod | 1.800m | Ø4mm 6m | B | FV |
| 608560 | Varilla de fibra / Fibre rod | 1.800m | Ø5mm 6m | B | FV |
| 608660 | Varilla de fibra / Fibre rod | 1.800m | Ø6mm 6m | B | FV |
| 608860 | Varilla de fibra / Fibre rod | 1.800m | Ø8mm 6m | B | FV |
| 608060 | Varilla de fibra / Fibre rod | 300m | Ø10mm 6m | B | FV |
| 608260 | Varilla de fibra / Fibre rod | 300m | Ø12mm 6m | B | FV |
| 608435 | Varilla transparente / Transparent rod | 900m | Ø4mm 3m | Tr | PS |

Pletinas contrapeso / Bottom weight bars

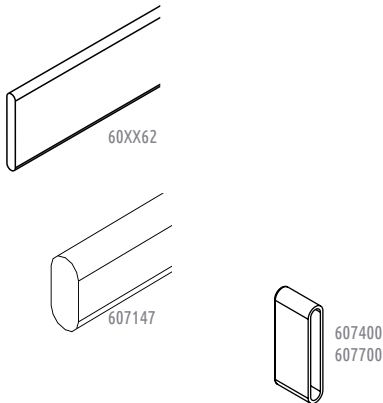

| Ref. | Artículo / Article | Uni. | Datos / Data | Color | Mat. |
|--------|--|--------|--------------|-------|------|
| 607262 | Pletina aluminio / Aluminium bottom bar | 180m | 2x25 132g/m | B An | Alum |
| 607362 | Pletina aluminio / Aluminium bottom bar | 180m | 3x20 159g/m | B An | Alum |
| 607462 | Pletina aluminio / Aluminium bottom bar | 90m | 3x25 200g/m | B An | Alum |
| 607562 | Pletina aluminio / Aluminium bottom bar | 90m | 3x30 240g/m | B An | Alum |
| 607762 | Pletina aluminio / Aluminium bottom bar | 90m | 3x40 322g/m | B | Alum |
| 607962 | Pletina aluminio / Aluminium bottom bar | 60m | 4x30 322g/m | B | Alum |
| 607862 | Pletina aluminio / Aluminium bottom bar | 60m | 4x40 427g/m | B | Alum |
| 607147 | Pletina de plástico / Plastic bottom bar | 200m | 8x18mm 4m | B | PVC |
| 607400 | Protector pletina / Bottom bar protector | 300 u. | 3x25mm | Tr | PE |
| 607700 | Protector pletina / Bottom bar protector | 300 u. | 3x40mm | Tr | PE |

Velcro / Velcro

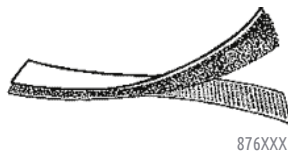

| Ref. | Artículo / Article | Uni. | Datos / Data | Color | Mat. |
|--------|-------------------------------------|------|--------------|-------|------|
| 876620 | Velcro felpa / Velcro loop | 25m | 20mm | B | PA |
| 876610 | Felpa con adhesivo / Adhesive loop | 25m | 20mm | B | PA |
| 876650 | Velour / Velour | 25m | 20mm | B | PA |
| 876920 | Velcro gancho / Velcro hook | 25m | 20mm | B | PA |
| 876910 | Gancho con adhesivo / Adhesive hook | 25m | 20mm | B | PA |

Cintas / Tapes

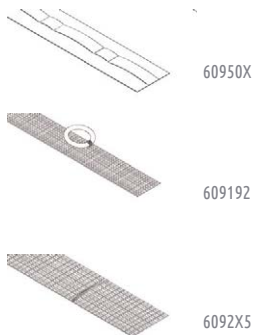

| Ref. | Artículo / Article | Uni. | Datos / Data | Color | Mat. |
|--------|--|------|--------------|-------|------|
| 609502 | Cinta VH / VH tape | 300m | 16mm | B | PA |
| 609503 | Cinta VH / VH tape | 300m | 16mm | Bg | PA |
| 609505 | Cinta VH / VH tape | 300m | 16mm | Tr | PA |
| 609184 | Cinta anillas Casafe / Casafe rings tape | 150m | 17mm 15cm | Tr | PA |
| 609192 | Cinta anillas Casafe / Casafe rings tape | 120m | 10mm 15cm | Tr | PA |
| 609215 | Cinta romana / Roman tape | 300m | 16mm 15cm | Tr | PA |
| 609225 | Cinta romana / Roman tape | 300m | 18mm 15cm | Tr | PA |
| 609205 | Cinta romana / Roman tape | 300m | 20mm 15cm | Tr | PA |

Cordones / Cords

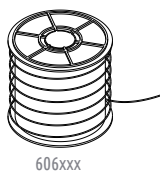

| Ref. | Artículo / Article | Uni. | Datos / Data | Color | Mat. |
|--------|--------------------|------|--------------|-------|------|
| 606100 | Cordón / Cord | 600m | Ø1,0mm | B | PET |
| 606120 | Cordón / Cord | 500m | Ø1,2mm | B | PET |
| 606140 | Cordón / Cord | 500m | Ø1,4mm | B | PET |

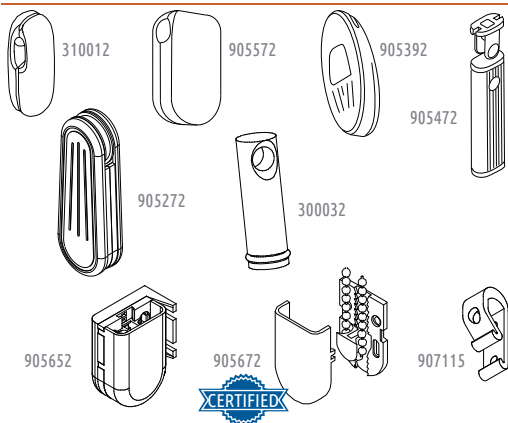

Contrapesos / Counterweights

| Ref. | Artículo / Article | Uni. | Datos / Data | Color | Mat. |
|--------|---|--------|----------------|-------------|------|
| 310012 | Contrapeso Rutroller / Rutroller count. | 60 u. | 21g Ø20x60 | B G N Bg Tr | PP |
| 905572 | Contrapeso Roma / Rome counterw. | 40 u. | 64g 59x37x20 | B | PP |
| 905392 | Contrapeso Turín / Turin counterweight | 40 u. | 48g 90x36x17 | B G N Bg | PP |
| 905472 | Contrapeso Sidney / Sydney counterw. | 40 u. | 110g 100x15x32 | B | ABS |
| 905272 | Contrapeso especial / Special counterw. | 32 u. | 115g 98x20x35 | B G N | PP |
| 300032 | Cont. Rutdecor / Rutdecor counterweight | 25 u. | 108g Ø20x65 | Cn Cr Gt | Met |
| 905652 | Tensor Lorca / Lorca taut | 50 u. | 47x22mm | B G N Bg | POM |
| 905672 | Tensor Murcia / Murcia taut | 250 u. | 47x32mm | B G N Bg | POM |
| 907115 | Tensor Yecla / Yecla taut | 100 u. | 50x20x16mm | Tr | PC |

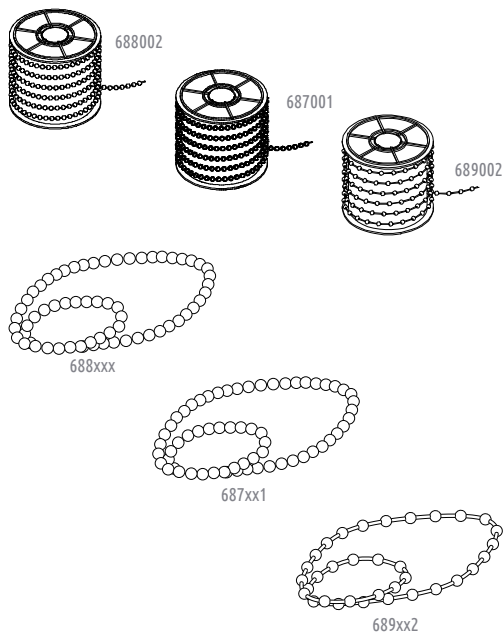

Cadenas / Chains

| Ref. | Artículo / Article | Uni. | Datos / Data | Color | Mat. |
|--------|-------------------------------------|------|--------------|-----------|------|
| 688002 | Cadena continua / Continuous chain | 200m | Ø4,5x6mm | 15 colors | POM |
| 687001 | Cadena metálica / Metal chain | 125m | Ø4,5x6mm | Cr | Met |
| 689002 | Cadena discontinua / Discont. chain | 250m | Ø4,5x12mm | 15 colors | POM |

| Aros cadena continua / Continuous chain rings | 100 u. | Ø4,5x6mm | B G Bg N M Tr | POM |
|---|----------------------------|----------------------------|---------------|-----|
| 688202 - 200cm=1,00m long. | 688254 - 250cm=1,25m long. | 688302 - 300cm=1,50m long. | | |
| 688352 - 350cm=1,75m long. | 688402 - 400cm=2,00m long. | 688452 - 450cm=2,25m long. | | |
| 688502 - 500cm=2,50m long. | 688602 - 600cm=3,00m long. | | | |

| Aros cadena metálicos / Metallic chain rings | 10 u. | Ø4,5x6mm | Cr | Met |
|--|----------------------------|----------------------------|----|-----|
| 687201 - 200cm=1,00m long. | 687251 - 250cm=1,25m long. | 687301 - 300cm=1,50m long. | | |
| 687351 - 350cm=1,75m long. | 687401 - 400cm=2,00m long. | 687501 - 500cm=2,50m long. | | |

| Aros cadena discontinua / Discontinuous chain rings | 100 u. | Ø4,5x12mm | B | POM |
|---|----------------------------|----------------------------|---|-----|
| 689202 - 200cm=1,00m long. | 689252 - 250cm=1,25m long. | 689302 - 300cm=1,50m long. | | |
| 689352 - 350cm=1,75m long. | 689402 - 400cm=2,00m long. | 689502 - 500cm=2,50m long. | | |

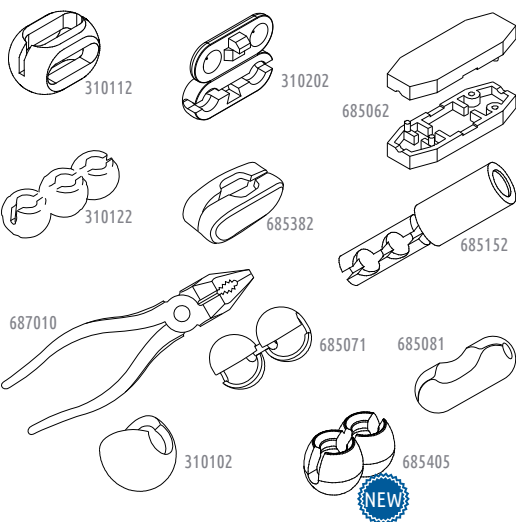

Empalmes cadena / Chain joints

| Ref. | Artículo / Article | Uni. | Datos / Data | Color | Mat. |
|--------|--|----------|--------------|-------------|------|
| 310112 | Empalme jaula / Cage joint | 200 u. | 8x8x12mm | 6 colors | PC |
| 310202 | Empalme cápsula / Capsule joint | 1.000 u. | Ø8x18mm | 6 colors | PP |
| 685062 | Empalme extra / Extra joint | 300 u. | 32mm | B | ABS |
| 310122 | Empalme 3 bolas / 3 Balls joint | 200 u. | Ø4,5x6mm | B G Bg N Tr | POM |
| 685382 | Empalme Castellón / Castellon joint | 100 u. | 17x7x7mm | B | PA |
| 685152 | Empalme cilindro / Cylinder joint | 500 u. | Ø4,5x18mm | B | POM |
| 687010 | Alicates para empalme / Splicing tool | 1 u. | 125x70x16mm | Zn | Met |
| 685071 | Empalme continuo 2bolas / 2Balls joint | 1.000 u. | Ø4,5x6mm | Zn | Met |
| 685081 | Empalme Valencia / Valencia joint | 100 u. | Ø6x13mm | Zn | Met |
| 310102 | Stopper cadena / Chain stopper | 500 u. | Ø8,5mm | B Tr | PC |
| 685405 | Empalme 2 bolas / 2 Balls joint | 200 u. | Ø8x14mm | Tr | PC |

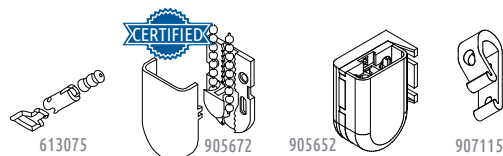

Control de tensión / Tension control

| Ref. | Artículo / Article | Uni. | Datos / Data | Color | Mat. |
|--------|-------------------------------------|--------|--------------|----------|------|
| 613075 | Clip escape cordón / Cord breakaway | 200 u. | max.4-6kg | Tr | PC |
| 905672 | Tensor Murcia / Murcia taut | 250 u. | 47x32mm | B G N Bg | POM |
| 905652 | Tensor Lorca / Lorca taut | 50 u. | 47x22mm | B G N Bg | POM |
| 907115 | Tensor Yecla / Yecla taut | 100 u. | 50x20x16mm | Tr | PC |